

Features

- Single-speed whirlpool offers performance and value, with 8 fully adjustable jets.
- Hydromassage flow and direction can be controlled at each jet.
- Built-in heater.
- Comfort Depth® design offers a convenient 19-inch step-over height while retaining the same depth as a standard 21-inch bath.
- Molded lumbar support offers extra comfort while bathing.
- Slotted overflow allows for deep soaking.
- Integral apron.
- Integral flange helps prevent water from seeping behind wall and simplifies alcove installation.
- Left-hand drain.
- Coordinates with other products in the Archer collection.

Material

- Acrylic

Hydrotherapy

- Whirlpool

Installation

- Three-wall alcove.

Additional Hydrotherapy Options

- Soaking Bath - K-1946-LA
- Soaking Bath + Bask heated surface - K-1946-LAW
- BubbleMassage air bath - K-1947-GLA
- BubbleMassage air bath + Bask heated surface - K-1947-GLAW
- VibrAcoustic - K-1947-VBLA
- VibrAcoustic + Bask heated surface - K-1947-VBLAW
- Whirlpool - K-1947-LA
- Whirlpool + heater - K-1947-HLA
- Whirlpool + Bask heated surface - K-1947-LAW
- Whirlpool + BubbleMassage air bath - K-1947-XHGLA

Required Products/Accessories

K-7271 Brass Slotted Overflow Bath Drain

or

K-7272 PVC Slotted Overflow Bath Drain

Recommended Products/Accessories

K-24916 Wireless Music Kit



ADA

Codes/Standards











ASME A112.19.7/CSA B45.10
CSA B45.5/IAPMO Z124
UL 1795
CSA C22.2 No. 218.2
ADA
ICC/ANSI A117.1

**KOHLER® Plastic Baths and Receptors
Lifetime Limited Warranty
KOHLER® Hydrotherapy Components
Five-Year Limited Warranty**

See website for detailed warranty information.

Available Colors/Finishes

Color tiles intended for reference only.

| Color | Code | Description |
|--|------|---------------|
|  | 0 | White |
|  | 96 | Biscuit |
|  | 47 | Almond |
|  | NY | Dune |
|  | 95 | Ice™ Grey |
|  | G9 | Sandbar |
|  | 33 | Mexican Sand™ |
|  | K4 | Cashmere |
|  | 58 | Thunder™ Grey |
|  | 7 | Black Black™ |

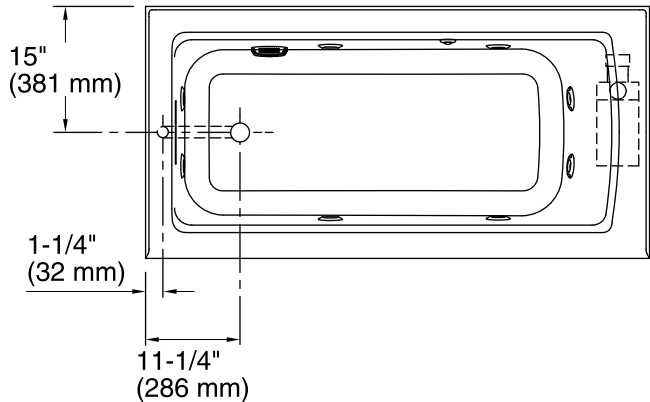

No change in measurements if connected with drain illustrated. (K-7272)

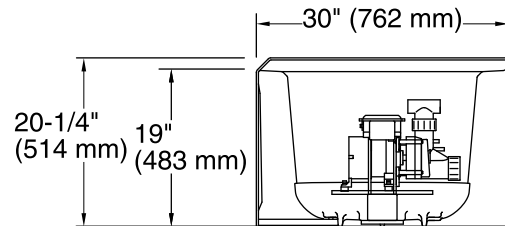
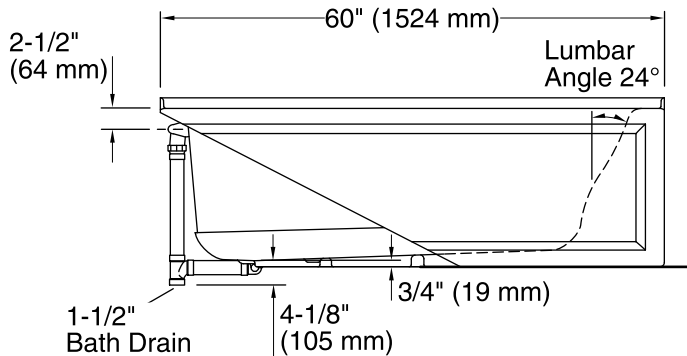
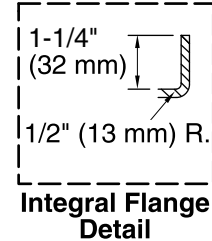

Required Electrical Service

Two dedicated circuits required, protected with Class A Ground-Fault Circuit-Interrupter (GFCI). Outside North America, this device may be known as a Residual Current Device (RCD).

Pump: 120 V, 15 A, 60 Hz
Heater: 120 V, 15 A, 60 Hz

Technical Information

All product dimensions are nominal.

Installation: Three-wall alcove
Drain location: Left
Basin area, bottom: 45-1/8" x 19-11/16" (1146 mm x 500 mm)
Basin area, top: 52-1/8" x 22-1/16" (1324 mm x 560 mm)
Weight: 113 lbs (51.3 kg)
Minimum floor load: 49 lbs/ft² (239.2 kg/m²)
Water depth: 15-1/8" (384 mm)
Water capacity: 57 gal (215.8 L)
Electrical component rating: Pump: 120 V, 7 A, 60 Hz
Heater: 120 V, 12.5 A, 60 Hz, 1500 W
Pump speed: Single
Minimum flat for door: 2" (51 mm)

Notes

Measure your actual product for rough-in details. Install this product according to the installation instructions.

The hot water supply should be 70% of the capacity of the bath or greater. Installations will vary.

Provide one grounded electrical outlet within 24" (610 mm) of each component.

ADA compliant when installed to the specific requirements of these regulations.