

CODE NUMBER

3250416

DESCRIPTION

1.0 gpf, Polished Chrome Finish, Single Flush, No Control Stop, Battery, G2 Exposed Sensor Urinal Flushometer.

DETAILS

- Flush Volume: 1.0 gpf (3.8 Lpf)
- Finish: Polished Chrome (CP)
- Power Type: Battery
- Battery Life: 6 years
- Valve: Diaphragm
- Valve Body Material: Semi-red Brass
- Fixture Type: Urinal
- Fixture Connection: Top spud
- Supply Pipe: ¾" (19mm)
- Control Stop: No (XD)

FEATURES

- Valve body, Cover, Tailpiece and Control Stop shall be in compliance with ASTM Alloy Classification for Semi-Red Brass
- Valve shall be in compliance to the applicable sections of ASSE 1037.

**COMPLIANCES & CERTIFICATIONS**

(ADA Compliant, cUPC Certified, BAA Compliant)

RECOMMENDED SPECIFICATION

Valve Body, Cover, Tailpiece and Control Stop shall be in conformance with ASTM Alloy Classification for Semi- Red Brass. Valve shall be in compliance with the applicable sections of ASSE 1037 and ANSI/ASME 112.19.2.

ELECTRICAL SPECIFICATIONS

- Battery Life: 6 years

VALVE OPERATING PRESSURE (FLOWING)

15–80 PSI (103–552 kPa). Specific fixtures may require greater minimum flowing pressure - consult manufacturer requirements.

DOWNLOADS

- [Optima Plus Valve Installation Instructions](#)
- [G2 Repair and Maintenance Guide](#)
- [Control Stop Repair and Maintenance Guide](#)
- [Flush Connections Flanges Repair and Maintenance Guide](#)
- [Tail Piece Repair and Maintenance Guide](#)
- [Sloan Optima Plus Repair and Maintenance Guide](#)
- [Additional Downloads](#)

NOTES

All information contained within this document subject to change without notice.

Looking for other variations of the G2 8188 product? [View the general spec sheet with all options.](#)

[Find a compatible urinal](#) for this flushometer.

[Find a compatible water closet](#) for this flushometer.

Sloan 10500 Seymour Ave, Franklin Park, IL 60131

Phone: 800.982.5839 • Fax: 800.447.8329 • sloan.com

ROUGH-IN

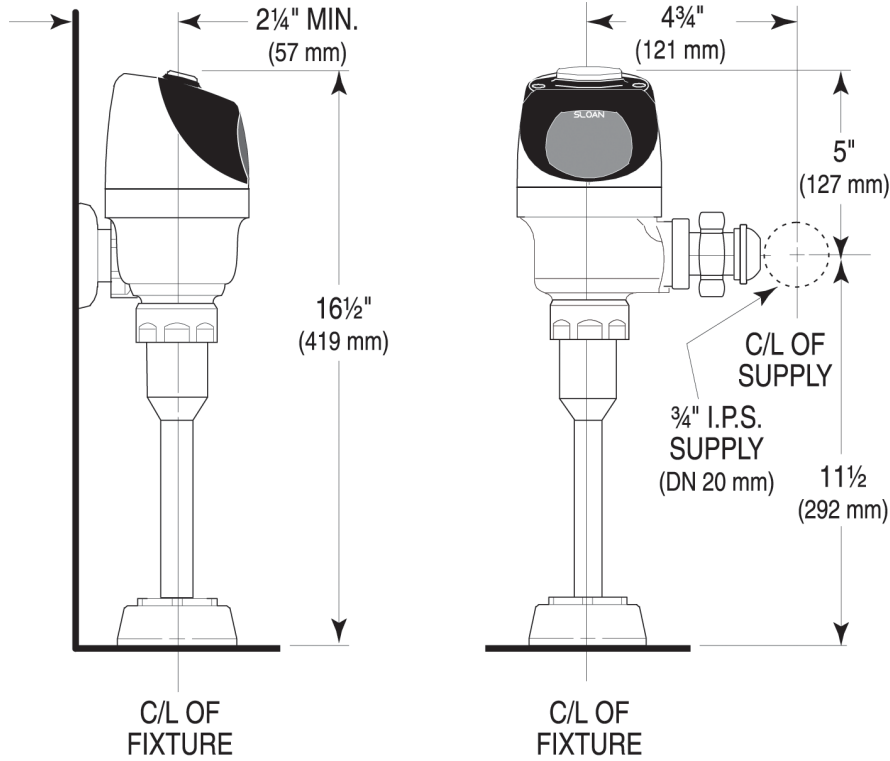

Sloan 10500 Seymour Ave, Franklin Park, IL 60131
 Phone: 800.982.5839 • Fax: 800.447.8329 • sloan.com