

Model Number: NEPXTH18-466

Special Notes: LED lights. This model is not available with heat lamps. Shown with optional duct cover (sold separately). Optional duct covers are available in standard and custom sizes.

WIDTH:	66"
DEPTH:	27"
HEIGHT:	18"
CFM:	1200
SONES:	6.6
AMPS:	7.5
# LIGHTS:	4

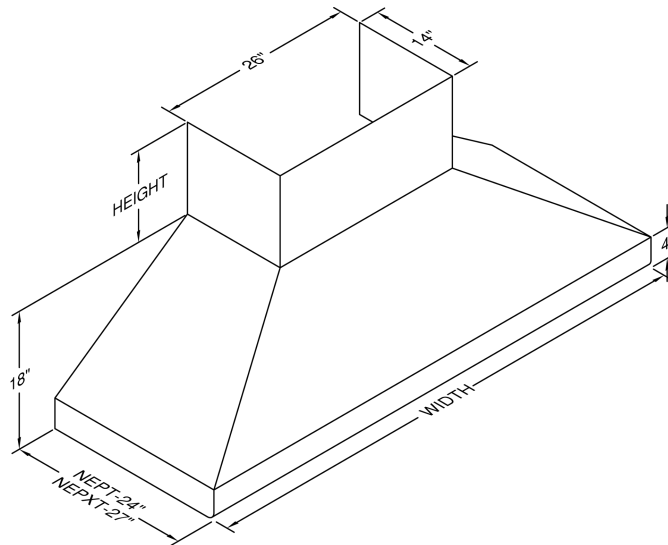

CONNECTION DIAGRAM

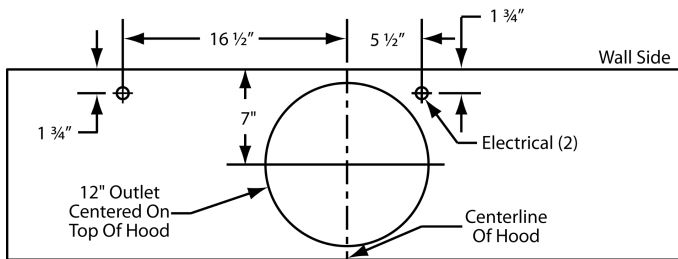

1200 CFM Double B200 Dual Blowers (Top View)

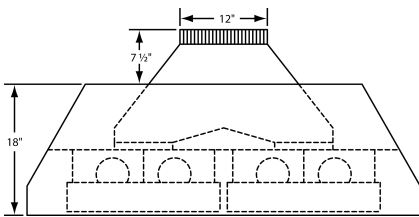

VP563 Standard Transition Installed (Front View)

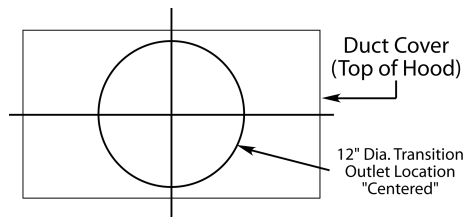

The transition shown (VP563) is installed in the hood at the factory as a standard item. It will be located in the exact center of the duct cover (left to right & front to rear).

REC. MOUNTING HEIGHT*

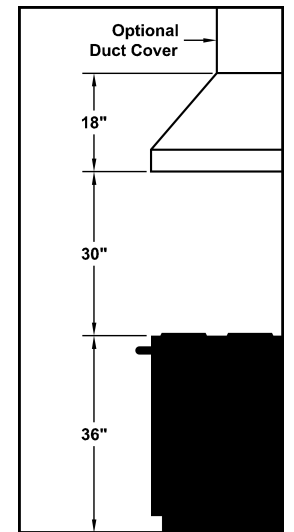

* Exceeding recommended mounting height may compromise performance.

ELECTRICAL/MECHANICAL SPECIFICATIONS FOR BLOWER UNIT

MODEL	VOLTS	AMPS+	HZ	RPM	CFM SP@0.0"	EQUIV CFM\$	CFM SP@0.1"	CFM SP@0.2"	CFM SP@0.3"	MIN. ROUND DUCT SIZE	SONES#
Two B200 Duals	115	7.5	60	1550	1200	1800	1062	960	860	12" (113 sq. in.)	6.6

+ This model is equipped with LED lighting: (3 lights: 42" - 53", 4 lights: 54" - 66").

\$ Because the Magic Lung blower uses centrifugal filtration rather than conventional baffle or mesh filters, the Magic Lung blower can handle cooking equipment with higher cubic feet per minute (CFM) requirements and can deliver equivalent CFM much more efficiently than other filtration systems. When comparing the Magic Lung with other blower units made by other manufacturers, use the "Equivalent CFM".

Ratings in accordance with the Standard Test Code by the Energy Systems Laboratory of the Texas Engineering Experiment Station.