

Technology

- Frameless, 3/8-inch-thick Crystal Clear tempered glass.
- Innovative roller design simplifies installation and provides out-of-plumb adjustability while glass is installed.
- Cushioned center guide provides quiet sliding action.
- Square towel bars, inside and outside, provide integrated storage on the door.
- CleanCoat® nanotechnology helps prevent bacteria, mildew and water stains on your glass, making it easy to clean and looking new.

Installation

- Sliding shower door.
- Not for use in hospitality.
- For residential use only.

Included Components

Additional Components:
Hardware kit



Codes/Standards

CPSC 16CFR 1201
ANSI Z97.1

KOHLER® One-Year Limited Warranty

See website for detailed warranty information.

Available Colors/Finishes

Color tiles intended for reference only.

Color	Code	Description
-------	------	-------------

	SHP	
--	-----	--

	NX	
--	----	--

	ABV	
--	-----	--

Available Glass Options

Code	Description
------	-------------

L	Crystal Clear
---	---------------

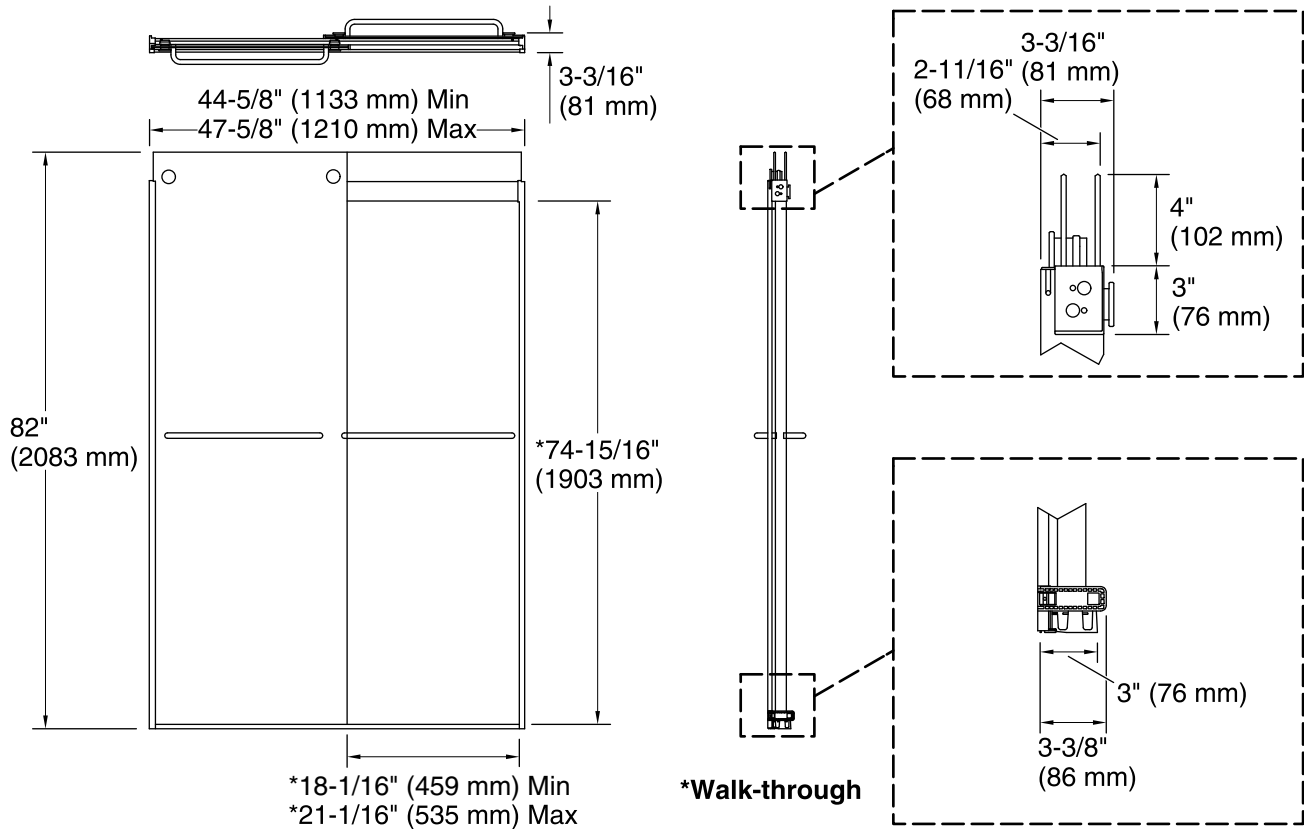

Technical Information

All product dimensions are nominal.

Installation type:	For shower base installation
Opening style:	Sliding/Bypass
Opening Width - Min:	44-5/8" (1133 mm)
Opening Width - Max:	47-5/8" (1210 mm)
Walk-through - Min:	18-1/16" (459 mm)
Walk-through - Max:	21-1/16" (535 mm)
Glass thickness:	3/8" (10 mm)
Glass coating:	CleanCoat®

Notes

Install this product according to the installation guide.

If replacing a shower door, the narrow wall jamb design of this door may not cover the existing shower door holes.

The vertical opening should be a minimum of 84-1/2" (2146 mm) to allow for installation clearance.