



Finesse™ Peak®

Headerless Frameless Pivot Shower Door

5698-30

Features

- Heavy 1/4" glass for strength and stability
- CleanCoat® technology creates a barrier between the water and the glass to help keep the door looking like new
- 3/8" (10 mm) out of plumb adjustability allows for easy installation.
- Left or right hand installation
- Tempered glass ensures maximum safety and durability

Installation

- Not for use in hospitality.
- For residential use only.

Included Components

Additional Components:
Hardware kit



Codes/Standards

ANSI Z97.1
CPSC 16CFR 1201

STERLING® Warranty - Bath and Shower Doors

See website for detailed warranty information.

Available Colors/Finishes

Color tiles intended for reference only.

Color	Code	Description
-------	------	-------------

ADR

N

S

Available Glass Options

Code	Description
------	-------------

G05 Clear

G03 Frosted

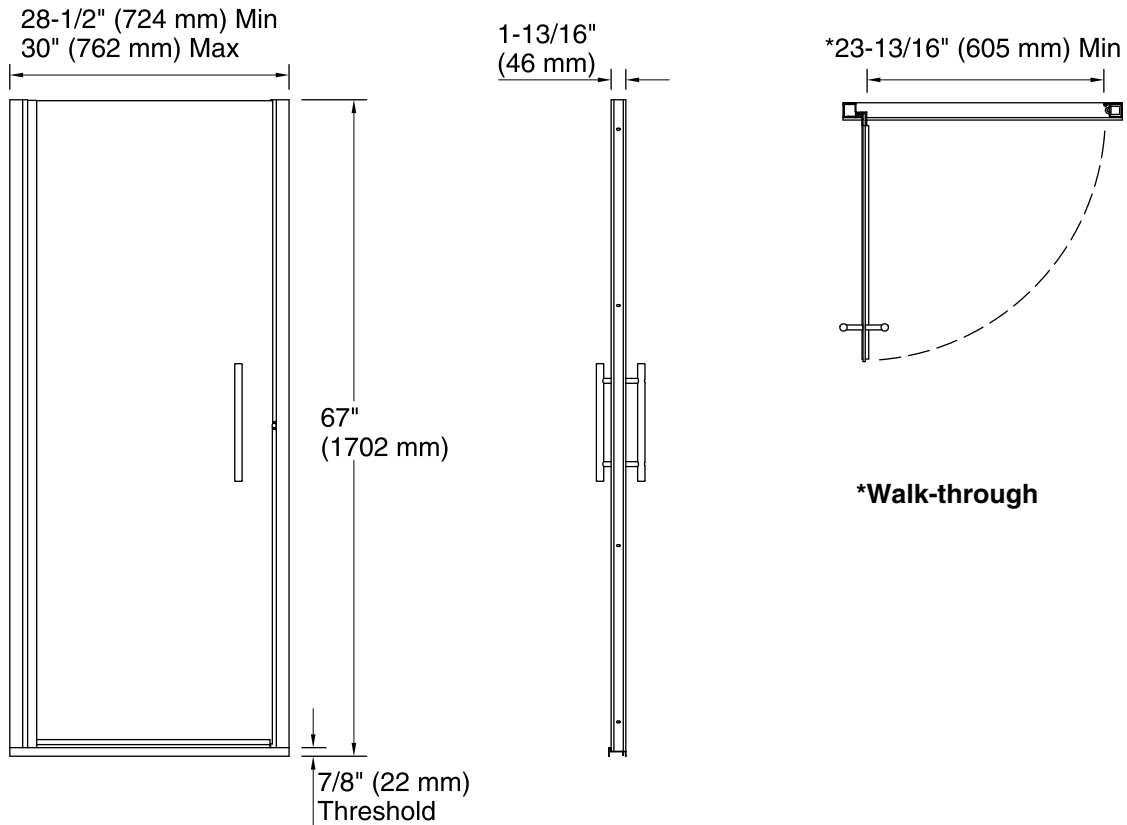

Technical Information

All product dimensions are nominal.
 Installation type: For shower base installation
 Opening Width - Min: 28-1/2" (724 mm)
 Opening Width - Max: 30" (762 mm)
 Walk-through - Min: 23-13/16" (605 mm)
 Glass thickness: 1/4" (6 mm)
 Glass coating: CleanCoat®

Notes

Install this product according to the installation instructions.
 The vertical opening should be a minimum of 67" (1702 mm) to allow for installation clearance.